

## JPS250/350 Series

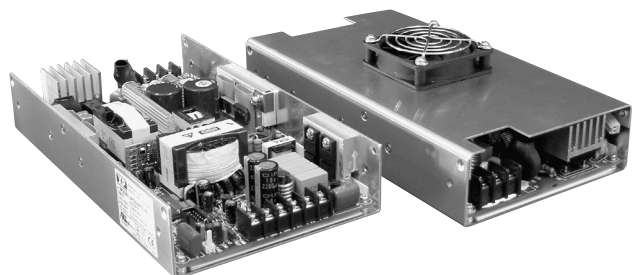

- 200 W / 300 W with Convection Cooling
- High Efficiency – up to 88%
- Meets 1U, Low Profile Requirements
- AC OK & DC OK Signals
- Zero Voltage Switching Technology
- Remote On/Off & Remote Sense
- 3 Year Warranty

## Specification

## Input

Input Voltage	• 85-264 VAC (170-370 VDC)
Input Frequency	• 47-63 Hz
Input Current	• 2.75 A/1.40 A max at 115 VAC/ 230 VAC (JPS250) 4.5 A/2.2 A max at 115 VAC/230 VAC (JPS350)
Inrush Current	• 30 A at 115 VAC, 60 A at 230 VAC
Power Factor	• 0.9 typical
Earth Leakage Current	• 3.0 mA max 264 VAC/60 Hz
Input Protection	• Internal T5 A, 250 VAC fuse (JPS250) Internal T6.3 A, 250 VAC fuse (JPS350)

## Output

Output Voltage	• See tables
Output Voltage Trim	• $\pm 10\%$ on output 1 only (VR1)
Initial Set Accuracy	• At 60% rated load $\pm 1\%$ on V1 & V2, $\pm 5\%$ on V3 & V4
Minimum Load	• Single output models: No minimum load required. Multi-output models, see note 4
Start Up Delay	• 2 s typical
Start Up Rise Time	• 80 ms typical (JPS250) 100 ms typical (JPS350)
Hold Up Time	• 20 ms min at low line & rated load
Line Regulation	• $\pm 0.5\%$ at rated load across input voltage range
Load Regulation	• $\pm 1\%$ for single output models & V1 & V2 of multi-output models, $\pm 5\%$ for V3 & V4
Transient Response	• 4% max deviation, recovery to within 1% in 500 $\mu$ s for a 25% load change
Ripple & Noise	• $\pm 1\%$ max pk-pk, 15 MHz bandwidth, see note 2 under model tables
Oversvoltage Protection	• 115-140% on single outputs & V1 of quad output models, recycle input to reset
Overtemperature Protection	• Shuts down at $+110$ °C, auto recovery, measured internally
Overload Protection	• 110-130% of max rated load on all O/Ps, auto recovery
Short Circuit Protection	• Trip and restart (Hiccup mode), auto recovery
Temp. Coefficient	• $\pm 0.05\%/^{\circ}\text{C}$
Remote Sense	• Compensates for up to 0.5 V drop
Remote On/Off	• On = Logic Low or Open, Off = Logic High
Current Share	• Current share on single output models & V1 & V2 of multi-output models (4 supplies can be paralleled)
Fan Output	• See mechanical notes for ordering information

## General

Efficiency	• Up to 88%
Isolation	• 3000 VAC Input to Output 1500 VAC Input to Ground 500 VAC Output to Ground
Switching Frequency	• 120 kHz typical for PFC and PWM
Power Density	• 4.96 W/In <sup>3</sup>
Signals	• AC OK, DC OK, Remote On/Off (see control and supervisory signals)
MTBF	• 125 kHrs to MIL-HDBK-217F at $+50$ °C, GB (JPS250) 146 kHrs to MIL-HDBK-217F at $+50$ °C, GB (JPS350)

## Environmental

Operating Temperature	• 0 °C to $+70$ °C, (see derating curve) Full power to $+50$ °C
Cooling	• 250 W with 18 CFM airflow (JPS250) 200 W convection cooling (JPS250) 350 W with 18 CFM airflow (JPS350) 300 W convection cooling (JPS350)
Operating Humidity	• 5-95% RH, non-condensing
Storage Temperature	• $-20$ °C to $+85$ °C
Operating Altitude	• 2000 m
Vibration	• 2 g, 10 Hz to 55 Hz, 30 mins each axis

## EMC &amp; Safety

Emissions	• EN55022, level B conducted FCC 20780, level B conducted
Harmonic Currents	• EN61000-3-2
ESD Immunity	• EN61000-4-2, level 3 Perf Criteria A
Radiated Immunity	• EN61000-4-3, 10 V/m Perf Criteria A
EFT/Burst	• EN61000-4-4, level 3 Perf Criteria A
Surge	• EN61000-4-5, level 3 Perf Criteria A
Dips and Interruptions	• EN61000-4-11, 30% 10 ms, 60% 100 ms, 100% 5000 ms, Perf Criteria A, B, B
Safety Approvals	• EN60950-1, UL60950-1, CSA C22.2 No. 60950-1, CE Mark LVD

## Models and Ratings

## JPS250 - Single Output **XP**

Output Power <sup>(1)</sup>	Output Voltage	Output Current		Ripple & Noise Pk-Pk	Model Number <sup>(3)</sup>
		Convection-cooled	18 CFM		
225 W	5 V	36.0 A	45.0 A	50 mV	JPS250PS05C
250 W	12 V	17.0 A	21.0 A	120 mV	JPS250PS12C
	15 V	13.5 A	17.0 A	120 mV	JPS250PS15C
	24 V	8.5 A	10.4 A	200 mV	JPS250PS24C
	48 V	4.3 A	5.2 A	200 mV	JPS250PS48C

### Notes

1. Maximum power with 18 CFM forced air is 250 W, or 200 W with convection cooling.
2. Ripple and noise measured over 15 MHz bandwidth with a 0.47  $\mu$ F capacitor.
3. For non-current share version delete suffix 'C' from model number.

## Mechanical Details

### All models (except JPS250PS05)

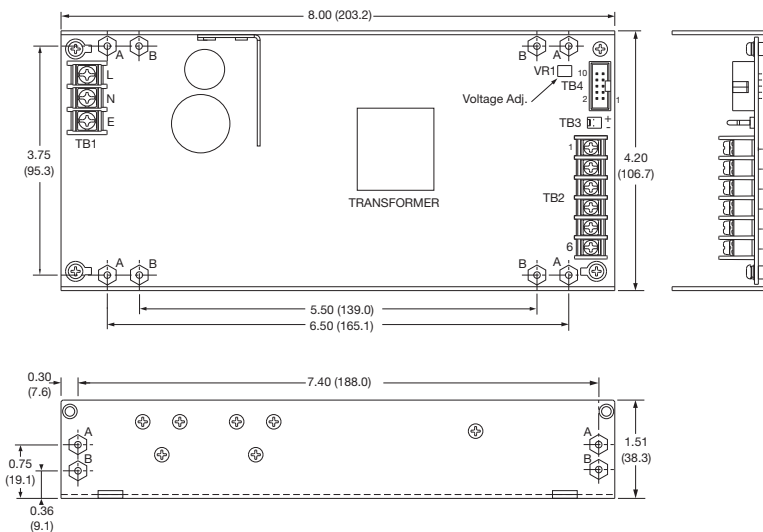

Pin	PIN CONNECTIONS		
	JPS250PS05	All other models	All models
1	+5 V	+V	Signal 0 V
2	+5 V	+V	DC OK
3	0 V	+V	AC OK
4	0 V	0 V	Remote On/Off
5	0 V	0 V	+Sense
6	0 V	0 V	-Sense
7	+5 V		Current Share <sup>(9)</sup>
8	+5 V		N/C
9			N/C
10			N/C

### Notes

1. TB3 is for fan, with Molex 5045-02A or equivalent.  
5 V model: 5 V at 390 mA, 24 V model: 24 V at 80 mA, all other models: 12 V at 112 mA
2. TB1 (AC input) and TB2 (DC output) are terminal blocks.
3. TB4 signal connector is Molex 70246-10 or equivalent.
4. Fan cover option available, order part number:  
5 V models: JPS250 F/CVR 5  
12, 15 & 48 V models: JPS250 F/CVR  
24 V models: JPS250 F/CVR 24  
Or add suffix '-E' to model number to receive unit with fan cover fitted. 4.2 x 8 x 2.48 (106.7 x 203.2 x 62.9).
5. For current share operation connect current share (pin 7) between units. For non 'C' models pin 7 (current share) is not used.
6. Input and output terminal screw tightening torque 9 lbs-in (1.0 Nm) maximum.

### JPS250PS05

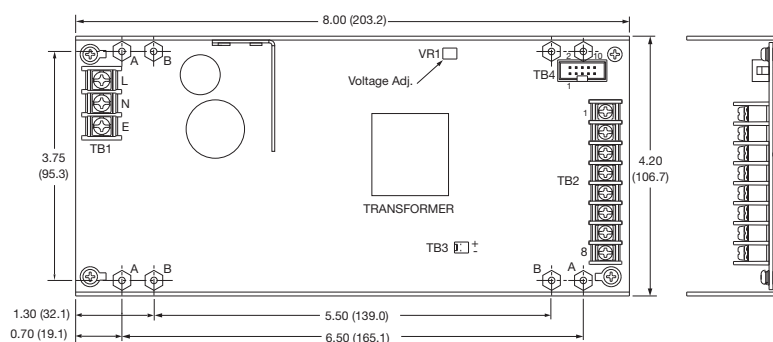

### Fixing Holes:

- A = #6-32 screw mounting holes
- B = M3 x 0.5 screw mounting holes
- Maximum mounting screw penetration is 0.16 (4.0) from chassis outer surface.

All dimensions are in inches (mm)

Tolerance:  $\pm 0.03$  (0.8) max

Weight: 1.65 lbs (750 g) approx.

## Models and Ratings

## JPS250 - Multi Output **XP**

Output 1			Output 2			Output 3			Output 4			Model Number <sup>(3)</sup>
Output V1	Conv. Cooled	Max 18 CFM	Output V2	Conv. Cooled	Max 18 CFM	Output V3	Conv. Cooled	Max 18 CFM	Output V4	Conv. Cooled	Max 18 CFM	
3.3 V	16.0 A	20 A	5 V	12 A	20 A	12 V	5 A	6 A	-12 V	1 A	2 A	JPS250PQ46C
5.0 V	17.5 A	30 A	12 V	7 A	8 A	-12 V	2 A	3 A	-5 V	1 A	2 A	JPS250PQ41C
5.0 V	20.0 A	25 A	12 V	4 A	6 A	24 V	2 A	3 A	-12 V	1 A	2 A	JPS250PQ47C
5.0 V	20.0 A	25 A	15 V	3 A	5 A	24 V	2 A	3 A	-15 V	1 A	2 A	JPS250PQ48C

### Notes

1. Maximum power with 18 CFM forced air is 250 W, or 200 W with convection cooling.
2. Ripple and noise measured over 15 MHz bandwidth with a 0.47 µF capacitor.
3. For non current share option delete suffix 'C' from model number.
4. All models require 2 A minimum load on V1. On V2, JPS250PQ46 requires 1 A and JPS250PQ41 requires 0.5 A.

† Available from Farnell. See pages 266-269.

^ Available from Newark. See pages 270-272.

## Mechanical Details

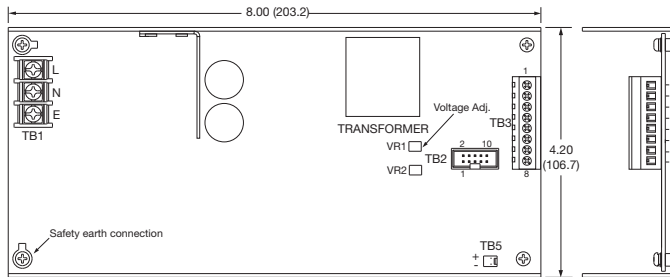

PIN CONNECTIONS - TB3				
Pin	PQ41	PQ46	PQ47	PQ48
1	+5 V	+12 V	+5 V	+5 V
2	+5 V	-12 V	+5 V	+5 V
3	0 V	+5 V	0 V	0 V
4	0 V	+5 V	0 V	0 V
5	0 V	0 V	0 V	0 V
6	-5 V	0 V	-12 V	-15 V
7	-12 V	0 V	+24 V	+24 V
8	+12 V	0 V	+12 V	+15 V
9		+3.3 V		
10		+3.3 V		

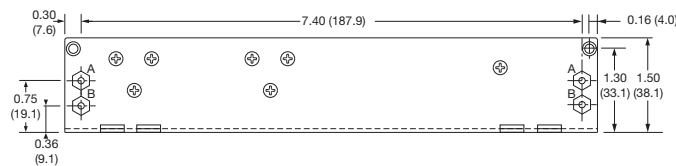

PIN CONNECTIONS - TB2				
Pin	PQ41	PQ46	PQ47	PQ48
1	+5 V +S	+3.3 V +S	+5 V +S	+5 V +S
2	+5 V PS <sup>(5)</sup>	+5 V -S	+5 V PS <sup>(5)</sup>	+5 V PS <sup>(5)</sup>
3	+12 V +S	+3.3 V PS <sup>(5)</sup>	+12 V +S	+15 V +S
4	DC OK	DC OK	DC OK	DC OK
5	+12 V -S	+5 V +S	+12 V -S	+15 V -S
6	+5 V -S	+3.3 V -S	+5 V -S	+5 V -S
7	+12 V PS <sup>(5)</sup>	+5 V PS <sup>(5)</sup>	+12 V PS <sup>(5)</sup>	+15 V PS <sup>(5)</sup>
8	Remote On/Off	Remote On/Off	Remote On/Off	Remote On/Off
9	AC OK	AC OK	AC OK	AC OK
10	0 V	0 V	0 V	0 V

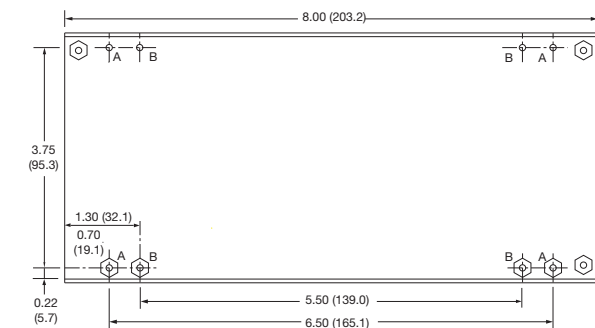

### Notes

1. TB5 is for fan with Molex 5045-02A or equivalent. 12 V at 112 mA.
2. TB1 (AC input) and TB3 (DC output) are terminal blocks.
3. TB2 signal connector is Molex 70246-10 or equivalent.
4. Fan cover option available, order part number:  
PQ41, PQ46 & PQ47: JPS250 F/CVR PQ48: JPS250 F/CVR 24  
or add suffix '-E' to model number to receive unit with fan cover fitted.  
4.2 x 8 x 2.48 (106.7 x 203.2 x 62.9).
5. PS - Current share on 'C' models only.  
No connection on standard models.
6. VR2 is for production setting only.
7. Input terminal screw tightening torque 9 lbs-in (1.0 Nm) maximum.
8. Output terminal screw tightening torque 4 lbs-in (0.45 Nm) maximum.

### Fixing Holes:

- A = #6-32 screw mounting holes
- B = M3 x 0.5 screw mounting holes
- Maximum mounting screw penetration is 0.16 (4.0) from chassis outer surface.

All dimensions are in inches (mm).  
Tolerance: ±0.03 (0.8) max.  
Weight: 1.65 lbs (750 g) approx.

## Models and Ratings

## JPS350 – Single Output **XP**

Output Power	Output Voltage	Output Current		Ripple & Noise Pk-Pk <sup>(2)</sup>	Model Number <sup>(1)</sup>
		Convection-cooled	18 CFM		
315 W	5 V	54.0 A	63.0 A	50 mV	JPS350PS05C
350 W	12 V	25.0 A	30.0 A	120 mV	JPS350PS12C
	15 V	20.0 A	24.0 A	120 mV	JPS350PS15C
	24 V	13.0 A	15.0 A	200 mV	JPS350PS24C
	48 V	6.5 A	7.3 A	200 mV	JPS350PS48C

### Notes

- For non-current share version delete suffix 'C' from model number.
- Ripple and noise measured over 15 MHz bandwidth with a 47  $\mu$ F electrolytic capacitor and 0.47  $\mu$ F ceramic capacitor.

† Available from Farnell. See pages 266-269.

^ Available from Newark. See pages 270-272.

## Mechanical Details

### All models (except JPS350PS05)

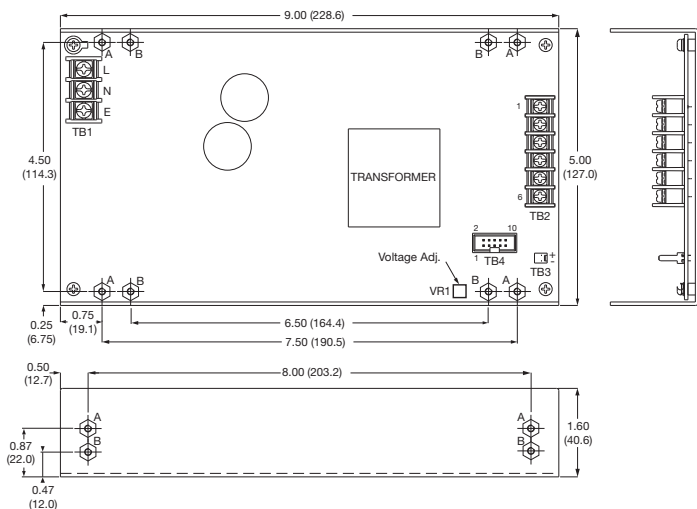

PIN CONNECTIONS			
Pin	TB2		TB4
	JPS350PS05	All other models	All models
1	+5 V	+V	N/C
2	+5 V	+V	N/C
3	0 V	+V	+Remote sense
4	0 V	0 V	DC OK
5	0 V	0 V	-Remote sense
6	0 V	0 V	N/C
7	+5 V		Current Share <sup>(5)</sup>
8	+5 V		Remote On/Off
9			AC OK
10			0 V

### Notes

- TB3 is for fan, with Molex 5045-02A or equivalent. 12 V at 112 mA (except JPS350PS05, 5 V at 390 mA).
- TB1 (AC input) and TB2 (DC output) are terminal blocks.
- TB4 signal connector is Molex 70246-10 or equivalent.
- Fan cover option available, order part number:  
5 V models: JPS350 F/CVR 5  
All other models: JPS350 F/CVR  
Alternatively, add suffix '-E' to model number to receive fan cover fitted to the unit 4.95 x 8.92 x 2.48 (127.0 x 228.6 x 62.9).
- For current share operation, connect current share (pin 7) between units. For non 'C' models pin 7 is not used.
- Input and output terminal screw tightening torque 9 lbs-in (1.0 Nm) maximum.

### Fixing Holes:

A = #6-32 screw mounting holes  
 B = M3 x 0.5 screw mounting holes  
 Maximum mounting screw penetration is 0.16 (4.0) from chassis outer surface.

All dimensions are in inches (mm)  
 Tolerance:  $\pm 0.03$  (0.8) max.  
 Weight: 2.12 lbs (960 g) approx.

### JPS350PS05

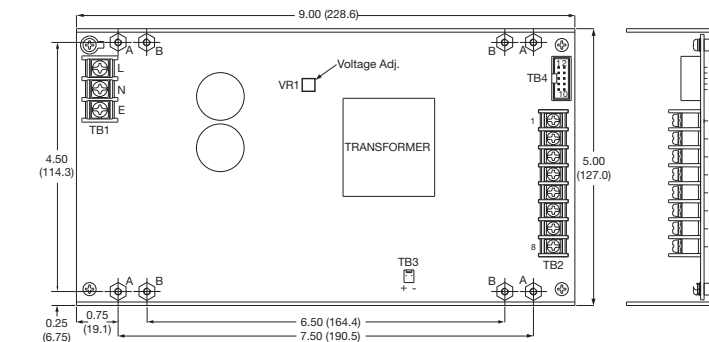

AC OK Signal

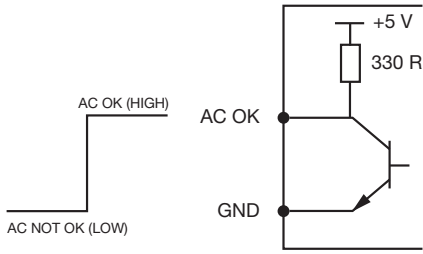

AC OK is a TTL signal which goes LOW when input falls out of specification. Source current is 1 mA, sink current is 6 mA.

DC OK Signal

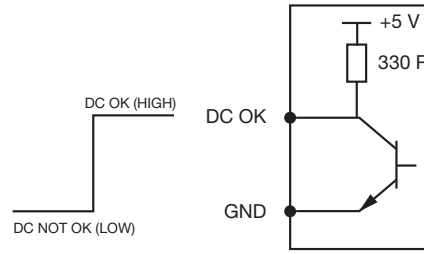

DC OK is a TTL signal which goes LOW when PSU is in an overcurrent condition, overvoltage condition, disabled or when output falls out of regulation. Source current is 1 mA, sink current is 6 mA.

Remote On/Off Control (Inhibit)

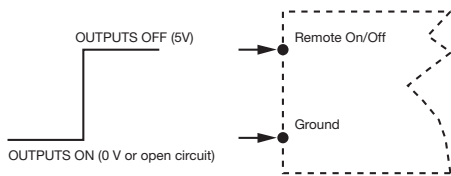

To turn off the output, apply 5 V to the remote On/Off.

Parallel Connection Utilizing Optional Current Share

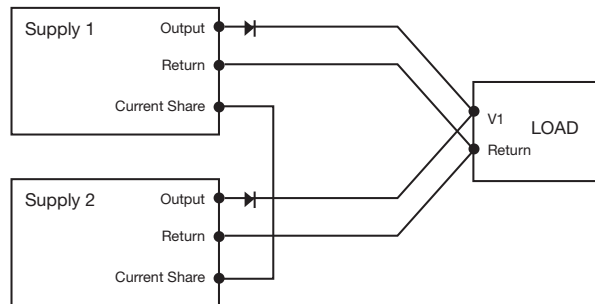

Remote Sense Connection

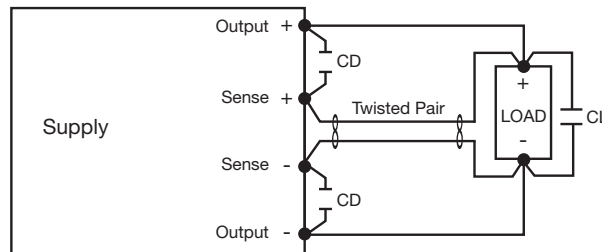

Notes:  
1. CD is 0.1  $\mu$ F ceramic capacitor.

2. CL is 47  $\mu$ F electrolytic capacitor.

Derating Curve

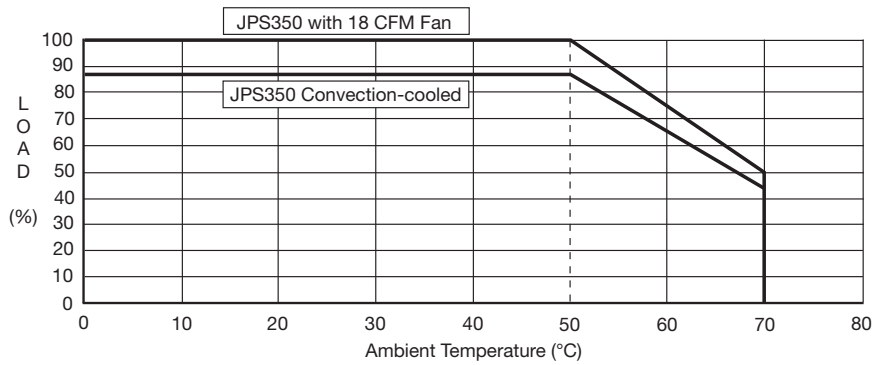
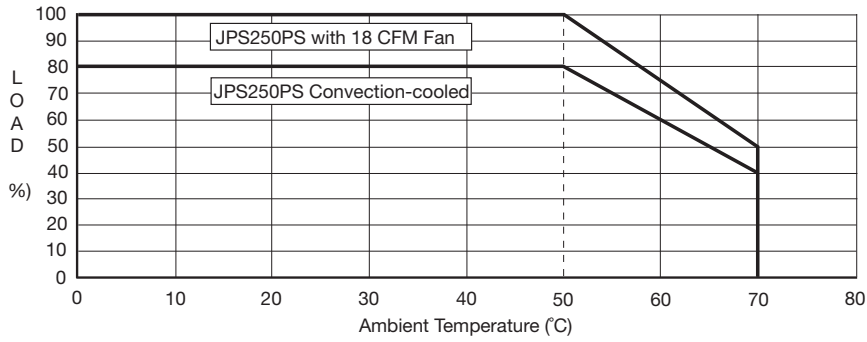

Cover Option

See mechanical details notes for ordering information.

